



TERMINALS & CONNECTORS  
ELECTRICAL PRODUCTS  
SHRINK TUBING  
TEW WIRE  
KITS

**PROPARTS™**  
HVAC PARTS & SUPPLIES

# TERMINALS & CONNECTORS



**THE BRANDS YOU TRUST FROM THE BRAND YOU RELY ON!**



# Table of Contents

## FEATURES & BENEFITS ..... 3

Shrink Tubing.....	3
Terminals & Connectors.....	4

## TERMINALS & CONNECTORS ..... 7

PP-RBS .....	7
PP-BBS .....	7
PP-YBS.....	7
PP-HS-BBS.....	7
PP-RR6.....	7
PP-RR10.....	7
PP-BR6.....	7
PP-BR10.....	7
PP-BR1/4.....	7
PP-YR10.....	7
PP-YR1/4.....	7
PP-RS6.....	7
PP-RS10.....	7
PP-BS6.....	7
PP-BS10.....	7
PP-YS10.....	7
PP-RQDM-250.....	8
PP-BQDM-250.....	8
PP-YQDM-250.....	8
PP-RQDF-250.....	8
PP-BQDF-187.....	8
PP-BQDF-250.....	8
PP-YQDF-250.....	8
PP-NRF-FI-250.....	8
PP-NBF-FI-250.....	8
PP-NYF-FI-250.....	8
PP-NRQDM-FI-250.....	8

PP-NBQDM-FI-250.....	8
PP-NRQDF-FI-250.....	9
PP-NBQDF-FI-250.....	9
PP-CES-22/14.....	9
PP-COM-LEADS-8.....	9
PP-COM-12/8.....	9
PP-HT-BQDF-250.....	9
PP-HT-BFF-250.....	10
PP-RQDF/M.....	10
PP-BQDF/M.....	10
PP-DMF-F.....	10
PP-DMF-PB.....	10
PP-BQDF/M.....	10
PP-HT-WCP1.....	10
PP-HT-WCP7.....	10
PP-HT-WCP8.....	10
PP-WC-GREY.....	11
PP-WC-BLUE.....	11
PP-WC-ORANGE.....	11
PP-WC-YELLOW.....	11
PP-WC-RED.....	11
PP-HT-WCB1.....	11
PP-HT-WCB3.....	11
PP-WCG-J500.....	11
PP-WCG-J1000.....	11
PP-WCB-J300.....	11
PP-WCB-J600.....	11
PP-WCO-J150.....	11
PP-WCO-J300.....	11
PP-WCY-J100.....	11
PP-WCY-J200.....	11
PP-WCR-J75.....	11

## SHRINK TUBING.....12

PP-SWT3/16-6-X.....	12
PP-SWT1/4-6-X.....	12
PP-DWA#2-6-X.....	12

## ELECTRICAL PRODUCTS.....12

PP-ASB0.....	12
PP-ASB1.....	12
PP-ASB2.....	12
PP-ASB3.....	12
PP-12ROMEX-J50.....	12
PP-34ROMEX-J25.....	12
PP-58G-J60.....	12

## TEW WIRE ..... 13

PP-TEW16/26-R.....	13
PP-TEW16/26-B.....	13
PP-TEW14/41-W.....	13
PP-TEW14/41-R.....	13
PP-TEW14/41-B.....	13
PP-TEW12/65-B.....	13

## CABLE TIES ..... 13

PP-CT0540ST-0-C.....	13
PP-CT0540ST-X-C.....	13
PP-CT0750ST-0-C.....	13
PP-CT0750ST-X-C.....	13
PP-CT0750ST-X-M.....	13
PP-CT1150ST-0-C.....	13
PP-CT1150ST-X-C.....	13
PP-CT1150ST-X-M.....	13
PP-CT1450ST-0-C.....	13
PP-CT1450ST-X-C.....	13
PP-CT0850MH-0-C.....	13
PP-CT0850MH-X-C.....	13

## CABLE TIE ACCESSORIES..... 13

PP-CCB1/4.....	13
PP-CCB3/8.....	13

## KITS..... 14

PP-25-002.....	14
PP-25-000.....	14
PP-25-010.....	14



### Single Wall Shrink Tubing (SWT)

- Highly flame-retardant low shrink temperature polyolefin tubing
- UL recognized, CSA approved
- Very flexible; minimal wrinkle when bent



### Dual Wall Adhesive Lined Shrink Tubing (DWA)

- Designed for insulating and sealing splices in an under-the-hood automotive environment
- The inner wall, with its unique specially formulated hot-melt adhesive, forms an outstanding barrier against automotive fluids and moisture



### Shrink Ratio:

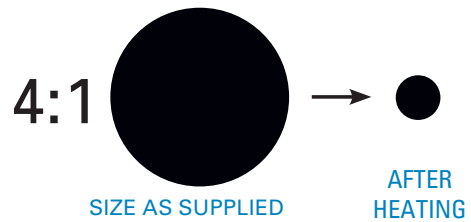
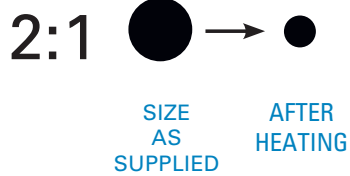

### Polyolefin Heat Shrinkable Tubing

PRODUCT TYPE	PRODUCT CSA SINGLE WALL	PRODUCT DWA DUAL WALL
Outer Wall Construction	Thin/ Flexible	Semi-Rigid
Inner Wall Construction	N/A	Adhesive Lining
Shrink Ratio	2 to 1	4 to 1
Minimum Shrink Temp.	70°C (158°F)	110°C (230°F)
Moisture Resistance	Low	High
Flame Retardancy	Good	Excellent
Abrasion Protection	Good	Excellent
Strain Relief & Insulation	Good	Excellent



## FEATURES & BENEFITS

### Pre-insulated Funnel Entry Vinyl Terminal

Vinyl insulation provides good dielectric strength.

Insulation has locating ridge for positioning crimping tool and supporting wire insulation.

Funnel design guides wire into crimping position without wire strand hangup.

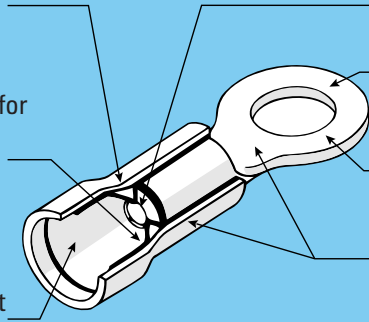

Multiple "V" grooves inside barrel provide firm grip on wire strands and current flow when crimped.

Electro tin plating stops corrosion, pitting and oxidation.

Terminal area constructed of annealed, electrolytic (ETP) copper insures maximum electrical conductivity.

### Uninsulated Butted Seam Terminal

- Constructed of electrolytic (ETP) copper
- Wire Range: 8 - 4/0 AWG
- Continuous Operating Temperature Range: 75°C (167°F)
- Voltage Rating: 300V / 600V

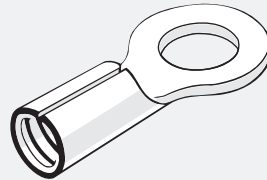

### Uninsulated Brazed Seam Terminal

- Constructed of electrolytic (ETP) copper
- Wire Range: 22 - 10 AWG
- Continuous Operating Temperature Range: 75°C (167°F)
- Voltage Rating: 300V / 600V

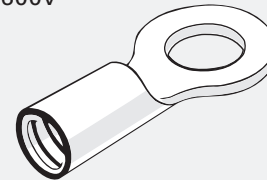

### Pre-insulated Funnel Entry Vinyl Terminal

- Vinyl insulation sleeve withstands the pressure of crimping
- Color coded for easy identification
- Wire Range: 22 - 4/0 AWG
- Continuous Operating Temperature Range: 75°C (167°F)
- Voltage Rating: 300V / 600V

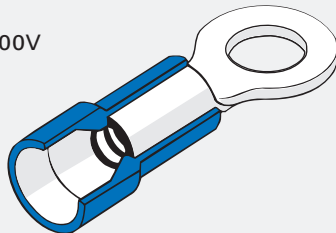

### Pre-insulated Funnel Entry Nylon Terminal

- Nylon insulation sleeve provides high dielectric strength
- Color coded for easy identification
- Wire Range: 22 - 10 AWG
- Continuous Operating Temperature Range: 105°C (221°F)
- Voltage Rating: 300V / 600V

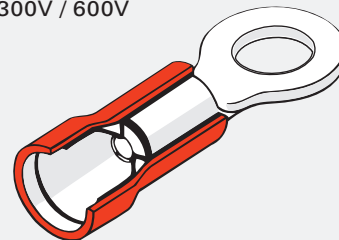





**Heat Shrinkable  
Terminals & Connectors**



**Wire Range:** 22 - 8 AWG  
**Shrink Temperature:** 180°C (356°F)  
**Voltage Rating:** 600 Volt max.  
**Operating Temperature:** -67°F to 257°F  
**Shrink Ratio:** 2:1

- Maximum electrical conductivity after crimping
- Funnel edged barrel for fast, easy insertion of wire
- Maximum holding power
- Tin plating prevents corrosion
- Wire range clearly stamped on neck of terminal
- Crimped for mechanical reliability
- Soldered for strength and conductivity
- Adhesive-lined polyolefin seals the connection
- Color coded for easy wire identification
- Translucent tubing allows for visual inspection

STANDARD SIZE	SCREW DIAMETER	HOLE DIAMETER	
#0	.060"		
#1	.073"	.094"	2.39mm
#2	.086"		
#3	.099"		
#4	.112"	.120"	3.02mm
#5	.125"		
#6	.138"	.146"	3.71mm
#8	.164"	.173"	4.39mm
#10	.190"	.198"	5.03mm
#12	.216"		
#14	.242"	.265"	6.75mm
1/4"	.250"		
5/16"	.312"	.328"	8.33mm
3/8"	.375"	.390"	9.92mm
7/16"	.437"	.453"	11.51mm
1/2"	.500"	.515"	13.10mm
5/8"	.625"	.656"	16.67mm
3/4"	.750"	.781"	19.84mm
7/8"	.875"	.906"	23.02mm
1"	1.000"	1.031"	26.19mm





# TERMINALS & CONNECTORS



## Terminals and Connector Identification

Wire Size (AWG)	Insulation Color Coding	Stud Size (S)	Tab Size (T)
26-24	Yellow	#4	.110"
22-18	Red	#6	.187"
16-14	Blue	#8	.205"
12-10	Yellow	1/4"	.375"
8	Red	5/16"	

	<b>RED</b>	<b>22 - 18 AWG</b>
	<b>BLUE</b>	<b>16 - 14 AWG</b>
	<b>YELLOW</b>	<b>12 - 10 AWG</b>

**Insulation sleeve is color coded by wire range for easy identification.**

**All measurements are in inches unless otherwise indicated.**

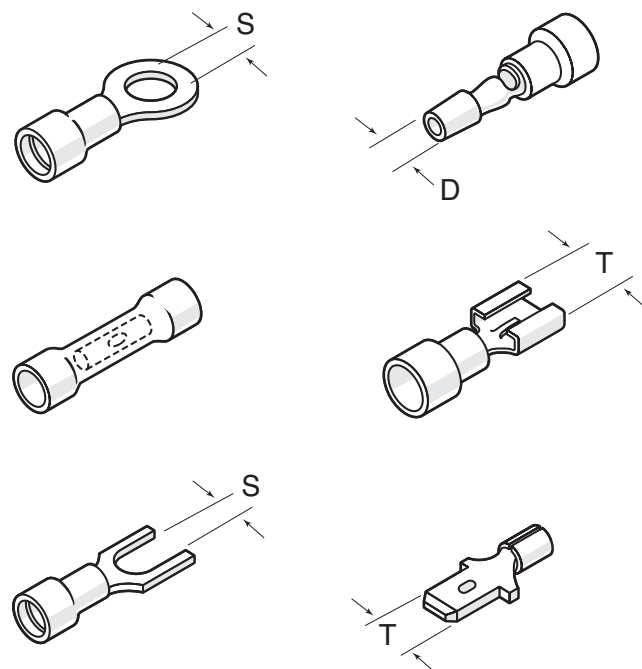



### Butt Connectors

Vinyl insulated; used to splice two wires together when repairing/installing an automotive wire harness

Part No.	Description	Qty/Pkg
PP-RBS	22-18 Butt Connector	100
PP-BBS	16-14 Butt Connector	100
PP-YBS	12-10 Butt Connector	75



### Heat Shrink Butt Connectors

Waterproof connector, when heated, the adhesive-lined nylon jacket seals the connection, protects splices from water, condensation, salt and corrosion

Part No.	Description	Qty/Pkg
PP-HS-BBS	16-14 AWG	25



### Ring Tongue Terminals

Vinyl insulated; funnel edged barrel for easy wire insertion, tin plating prevents corrosion

Part No.	Description	Qty/Pkg
PP-RR6	22-18 Ring Tongue #6	100
PP-RR10	22-18 Ring Tongue #10	100
PP-BR6	16-14 Ring Tongue #6	100
PP-BR10	16-14 Ring Tongue #10	100
PP-BR1/4	16-14 Ring Tongue 1/4"	75
PP-YR10	12-10 Ring Tongue #10	75
PP-YR1/4	12-10 Ring Tongue 1/4"	60

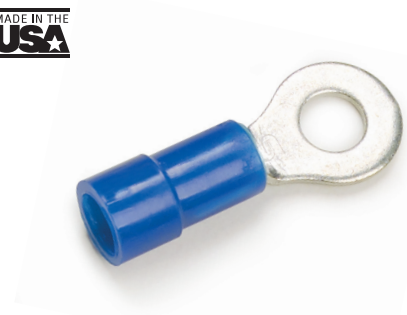

### Block Spade Tongue Terminals

Vinyl insulated; funnel edged barrel for easy wire insertion, tin plating prevents corrosion

Part No.	Description	Qty/Pkg
PP-RS6	22-18 Block Spade Tongue #6	100
PP-RS10	22-18 Block Spade Tongue #10	100
PP-BS6	16-14 Block Spade Tongue #6	100
PP-BS10	16-14 Block Spade Tongue # 10 Stud	100
PP-YS10	12-10 Block Spade Tongue # 10 Stud	75





## TERMINALS & CONNECTORS



### Male Quick Disconnect Terminals

Vinyl insulated; funnel edged barrel for easy wire insertion, tin plating prevents corrosion



Part No.	Description	Qty/Pkg
PP-RQDM-250	22-18 Male Quick Disconnect .250"	100
PP-BQDM-250	16-14 Male Quick Disconnect .250"	100
PP-YQDM-250	12-10 Male Quick Disconnect .250"	75



### Female Quick Disconnect Terminals

Vinyl insulated; funnel edged barrel for easy wire insertion, tin plating prevents corrosion



Part No.	Description	Qty/Pkg
PP-RQDF-250	22-18 Female Quick Disconnect .250"	100
PP-BQDF-187	22-18 Female Quick Disconnect .187"	100
PP-BQDF-250	16-14 Female Quick Disconnect .250"	100
PP-YQDF-250	12-10 Female Quick Disconnect .250"	75



### Female Quick Disconnect 90° Flag Terminals

Nylon fully insulated; excellent resistance to aging, cracking, grease, oil, water and high impact resistance



Part No.	Description	Qty/Pkg
PP-NRF-FI-250	22-18 Female Quick Disconnect Flag, 50 Nylon Fully Insulated .250"	50
PP-NBF-FI-250	16-14 Female Quick Disconnect Flag, Nylon Fully Insulated .250"	50
PP-NYF-FI-250	12-10 Female Quick Disconnect Flag, Nylon Fully Insulated .25"	30

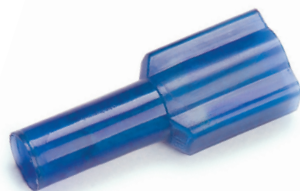

### Male Nylon Couplers

Nylon fully insulated; excellent resistance to aging, cracking, grease, oil, water and high impact resistance



Part No.	Description	Qty/Pkg
PP-NRQDM-FI-250	22-18 Male Quick Disconnect Coupler 40 Nylon Fully Insulated .250"	40
PP-NBQDM-FI-250	16-14 Male Quick Disconnect Coupler 40 Nylon Fully Insulated .250"	40





### Female Nylon Couplers

Nylon fully insulated; excellent resistance to aging, cracking, grease, oil, water and high impact resistance

Part No.	Description	Qty/Pkg
PP-NRQDF-FI-250	22-18 Female Quick Disconnect Coupler, Nylon Fully Insulated .250"	40
PP-NBQDF-FI-250	16-14 Female Quick Disconnect Coupler, Nylon Fully Insulated .250"	40

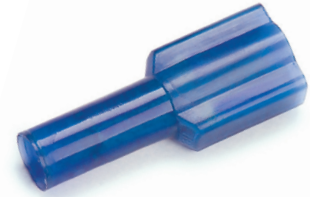

### Closed End Connectors

Used in terminating multiple wire applications

Part No.	Description	Qty/Pkg
PP-CES-22/14	22-14 AWG Closed End Connector	100



### Compressor Hook-up Lead Kits

Each kit includes 3 THHN 8" wire leads and 3 12-10 AWG heat shrinkable butt connectors enabling the technician to create an environmentally sealed wire connection

Part No.	Description	Qty/Pkg
PP-COM-LEADS-8	10 AWG 8" Compressor Hook Up Lead Kit	1 kit



### Compressor Terminals

12-8 AWG Female flag-style compressor terminal .250"

Part No.	Description	Qty/Pkg
PP-COM-12/8	12-8 Compressor Terminal	25

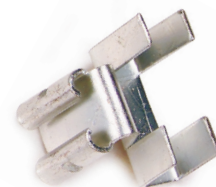

### High Temperature Female Quick Disconnects

Steel construction with nickel plating; 900°F (482°C) continuous temperature rating; 1200°F (649°C) intermittent temperature rating

Part No.	Description	Qty/Pkg
PP-HT-BQDF-250	16-14 High Temp Female Quick Disconnect .250"	100







## TERMINALS & CONNECTORS



### High Temperature Female Quick Disconnect 90° Flag Terminals

Steel construction with nickel plating  
900°F (482°C) continuous temperature rating  
1200°F (649°C) intermittent temperature rating



Part No.	Description	Qty/Pkg
PP-HT-BFF-250	16-14 High Temp Female Quick Disconnect Flag .250"	100



### Multi-Stack Disconnect Terminals

Vinyl insulated; male-female quick disconnect (piggy-back style) has a tongue portion that grips a male quick disconnect and a tongue extension that is to be gripped by a female quick disconnect



Part No.	Description	Qty/Pkg
PP-RQDF/M	22-18 Multi-Stack Disconnect .250"	30
PP-BQDF/M	16-14 Multi Stack Disconnect .250"	30



### Special Adapters

Double male-female adapters; interconnects two connectors that are already attached to wires; perfect for various wire tapping and splicing applications



Part No.	Description	Qty/Pkg
PP-DMF-F	Double Male-Female Adapter, 60 Flat .250"	60
PP-DMF-PB	Double Male Female Adapter, 40 Piggy Back .250"	40



### Porcelain Wire Connectors

The porcelain high temperature wire connector is for intense heat applications; rated up to 1,900°F (1,037°C); 300 volts; funneled entry guides wires into threaded compression compartment



Part No.	Description	Qty/Pkg
PP-HT-WCP1	High Temp Porcelain Wire Nut 18-14 GA MIN 2-4 18 GA, MAX 1-16 GA & 1-14 GA	10
PP-HT-WCP7	High Temp Porcelain Wire Nut 18-12 GA MIN 2-5 18 GA, MAX 1-12 GA & 1-16 GA	10
PP-HT-WCP8	High Temp Porcelain Wire Nut 14 GA MIN 2-14 GA, MAX 3-14 GA	10



**Twist-on Wire Connectors**

Seal Sure grip ribs improve grasping ability and comfort; threaded funnel entry guides wire into the connector easily; deep skirt entry provides protection from flash-over and shorts; fixed square spring provides a more secure grip on conductors; easy to install

Part No.	Description	Qty/Pkg
PP-WC-BLUE	22-14 AWG Blue	100
PP-WC-GREY	22-14 AWG Grey	100
PP-WC-ORANGE	22-14 AWG Orange	60
PP-WC-YELLOW	22-10 AWG Yellow	50
PP-WC-RED	22-10 AWG Red	35



**Twist-on Wire Connectors**

High Temperature 302° F / 150° C

Thermoplastic shell is specially designed to withstand extreme heat build-up found in high-wattage fixtures and signs

Part No.	Description	Qty/Pkg
PP-HT-WCB1	22-18 AWG Black	100
PP-HT-WCB3	22-14 AWG Black	50



**Twist-on Wire Connectors**

Bulk Packs – Tamperproof

Seal Sure grip ribs improve grasping ability and comfort; threaded funnel entry guides wire into the connector easily; deep skirt entry provides protection from flash-over and shorts; fixed square spring provides a more secure grip on conductors; easy to install

Part No.	Description	Qty/Pkg
PP-WCG-J500	22-14 AWG Grey (Jar)	500
PP-WCG-J1000	22-14 AWG Grey (Jar)	1000
PP-WCB-J300	22-14 AWG Blue (Jar)	300
PP-WCB-J600	22-14 AWG Blue (Jar)	600
PP-WCO-J150	22-14 AWG Orange (Jar)	150
PP-WCO-J300	22-14 AWG Orange (Jar)	300
PP-WCY-J100	22-10 AWG Yellow (Jar)	100
PP-WCY-J200	22-10 AWG Yellow (Jar)	200
PP-WCR-J75	22-10 AWG Red (Jar)	75





## SHRINK TUBING/ELECTRICAL PRODUCTS

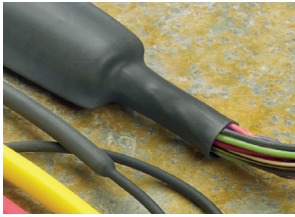

### Single Wall Shrink Tubing (SWT)

Highly flame-retardant low shrink temperature polyolefin tubing; 2:1 shrink ratio



Part No.	Description	Qty/Pkg
PP-SWT3/16-6-X	3/16" Single Wall Tubing, Black, 6" Length	12
PP-SWT1/4-6-X	1/4" Single Wall Tubing, Black, 6" Length	12



### Dual Wall Adhesive Lined Shrink Tubing (DWA)

The inner wall with its unique specially formulated hot-melt adhesive forms an outstanding barrier against automotive fluids and moisture; 4:1 shrink ratio

Part No.	Description	Qty/Pkg
PP-DWA#2-6-X	.293" Dual Wall Adhesive Lined, Black, 6" Length	8



### Anti-Short Bushings

Protect conductor insulation from sharp edges where the flexible metal conduit or armored cables are cut; for indoor use; easy to install; size of armored cable: 4/14, 3/14, 2/14, 3/12, 2/12



Part No.	Description	Qty/Pkg
PP-ASB0	5/16" Anti-Short Bushing - Red	40
PP-ASB1	3/8" Anti-short Bushing - Red	40
PP-ASB2	7/16" Anti-Short Bushing - Red	40
PP-ASB3	1/2" Anti-Short Bushing - Red	20

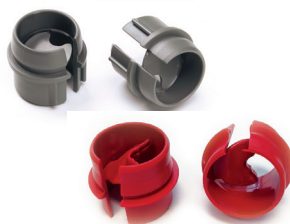

### Non-Metallic Romex Connectors

Fits knock-outs in electrical boxes; stops movement and protects wire from sharp edges of knock-out hole

Part No.	Description	Qty/Pkg
PP-12ROMEX-J50	1/2" Romex Connector - Grey	50
PP-34ROMEX-J25	3/4" Romex Connector - Red	25



### Non-Metallic Snap-In Connectors

Connectors for non-metallic sheathed cable

Part No.	Description	Qty/Pkg
PP-NMSI050-J50	1/2" (Trade size: 16)	Jar of 50
PP-NMSI050	1/2" (Trade size: 16)	1



### Grommets

Protects wires and harnesses as they pass through sheet metal, firewalls and truck beds

Part No.	Description	Qty/Pkg
PP-58G-J60	5/8 x 1/16 x 7/8 x 1-1/8 x 5/16	60



### Thermoplastic Equipment Wire

For internal wiring of electrical or electronic equipment, panels, motor and transformer lead; solid or stranded bare copper with pvc insulation 105°C (221°F)



Part No.	Description	Qty/Pkg
PP-TEW16/26-R	16/26 Red TEW	100'
PP-TEW16/26-B	16/26 Black TEW	100'
PP-TEW14/41-W	14/41 White TEW	100'
PP-TEW14/41-R	14/41 Red TEW	100'
PP-TEW14/41-B	14/41 Black TEW	100'
PP-TEW12/65-B	12/65 Black TEW	100'

Nylon cable ties are one piece design secures and positions wire bundles, cable, hoses, etc, with one mechanical fastener



### Intermediate Nylon Cable Ties

Part No.	Description	Type	Qty/Pkg
PP-CT0540ST-0-C	5.8" 40 lb Cable Tie, Natural	Type 21	100
PP-CT0540ST-X-C	5.8" 40 lb Cable Tie, UV Black	Type 21	100

### Standard Nylon Cable Ties

Part No.	Description	Type	Qty/Pkg
PP-CT0750ST-0-C	7.5" 50 lb Cable Tie, Natural	Type 21S	100
PP-CT0750ST-X-C	7.5" 50 lb Cable Tie, UV Black	Type 21S	100
PP-CT0750ST-X-M	7.5" 50 lb Cable Tie, Black	Type 21S	1000
PP-CT1150ST-0-C	11.2" 50 lb Cable Tie, Natural	Type 21S	100
PP-CT1150ST-X-C	11.2" 50 lb Cable Tie, UV Black	Type 21S	100
PP-CT1150ST-X-M	11.2" 50 lb Cable Tie, Black	Type 21S	1000
PP-CT1450ST-0-C	14.5" 50 lb Cable Tie, Natural	Type 21S	100
PP-CT1450ST-X-C	14.5" 50 lb Cable Tie, UV Black	Type 21S	100



### Mounting Hole Cable Ties

Part No.	Description	Mechanical Strength	Type	Qty/Pkg
PP-CT0850MH-0-C	8" 50 lb Mounting Hole, Natural	45 lb / 20.4 kg	Type 21	100
PP-CT0850MH-X-C	8" 50 lb Mounting Hole, UV Black	45 lb / 20.4 kg	Type 21S	100



### Nylon Cable Clamps

Designed to secure the routing of cables, harnesses and hoses

Part No.	Qty/Pkg
PP-CCB1/4	100
PP-CCB3/8	100







KITS



### Solderless Terminal Kit

An economical 18 compartment plastic kit box containing 450 of the most popular solderless terminals and connectors.



ProParts graphics appear on the label set with a matrix chart on the inside lid describing the parts, illustrations and individual re-order part numbers.

Part No.	Description	Qty/Pkg
PP-25-002	Solderless Terminal Kit 18 Compartment Box Contains 450 Piece Assortment	50



### Ratchet Action Crimp Tool Kit with 4 Interchangeable Dies

- Designed for the professional that insists on the best available commercial grade full cycle crimp tool
- System integrity is maintained when components are terminated with this tool
- Ergonomic progressive pivoting design provides maximum crimping force with reasonable hand pressure
- Ratcheted design eliminates variability from crimp to crimp

Part No.	Description
PP-25-000	Ratchet Action Crimp Tool Kit, 4 dies Crimp Die "A" for insulated terminals 22-10 AWG (.33 mm to 5.26 mm) Crimp Die "C" for insulated quick disconnect terminals 22-10 AWG (.33 mm to 5.26 mm) Crimp Die "22-18 1/8" for uninsulated and high-temperature terminals 22-8 AWG (.33 mm to 8.36 mm) Crimp Die "F" for fully insulated flag terminals 22-14 AWG (.33 mm to 2.08 mm)



### 22-10 Twist-On Wire Connectors Kit

A convenient way to store the complete assortment of color-coded twist-on connectors. These connectors are used daily by HVAC/R technicians. Fixed square spring provides a more secure grip on conductors.



Part No.	Description
PP-25-010	22-10 AWG Twist on Wire Connector Kit 375 Piece Assortment





**PROPARTS™**  
HVAC PARTS & SUPPLIES

ELECTRICAL CONNECTORS  
SPECIALTY ADAPTORS  
KITS  
CABLE TIES  
HEAT SHRINK TUBING  
THERMOPLASTIC EQUIPMENT WIRE





# PRO TO GO!

**THE BRANDS YOU TRUST FROM THE BRAND YOU RELY ON!**



Where applicable, our products are listed or recognized by the Canadian Standards Association and Underwriter's Laboratories. The products featured in this literature are not designed, engineered or assembled by PROParts or any of its affiliated organizations. To verify the information provided, please contact the original manufacturer. For additional information, please contact your local PROParts representative. Our continuing commitment to quality products may mean a change in specifications without notice.